

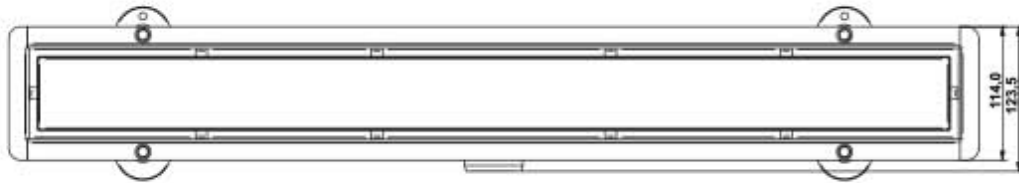

**74576, 74577, 74578, 74579, 74571**

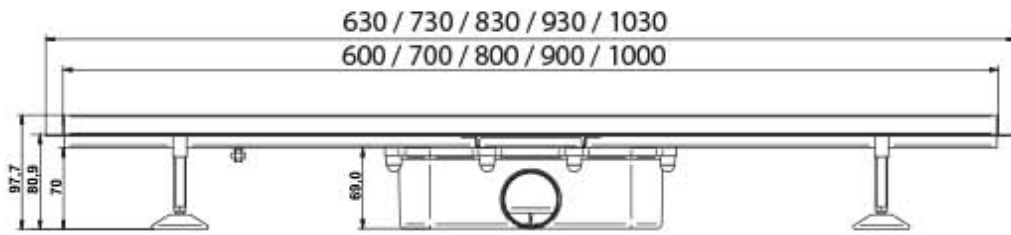

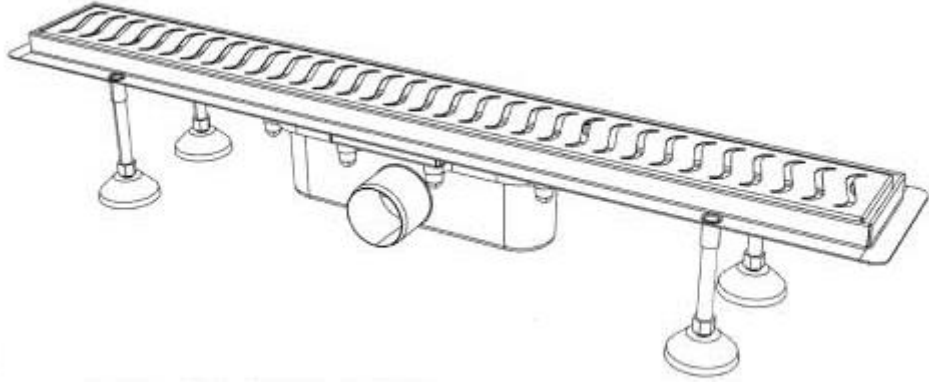

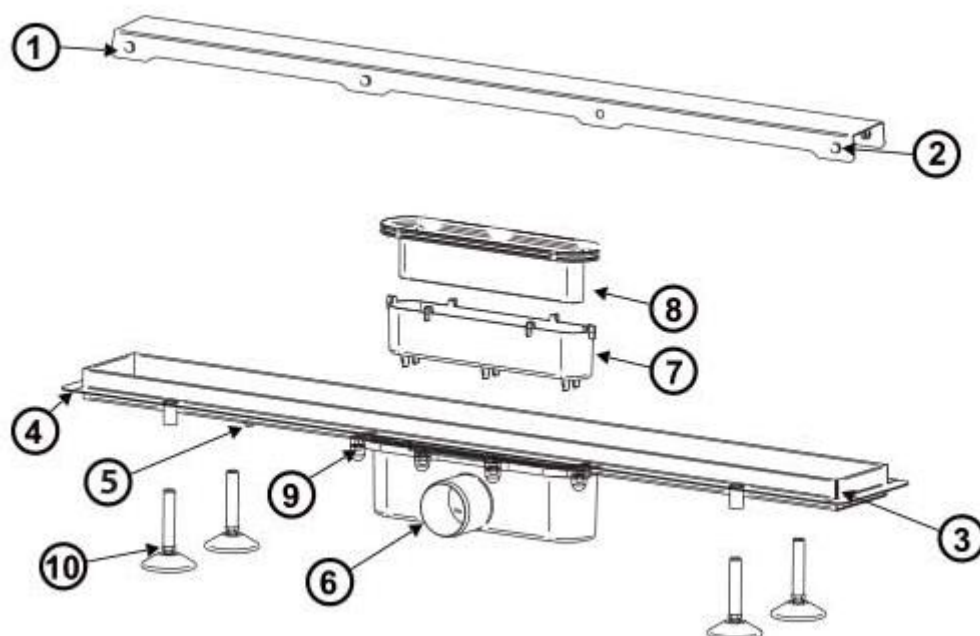

- CZ**
1. Rošt
  2. Gumové distanční podložky
  3. Žlabu (tělo žlabu)
  4. Příruba
  5. Uzemnění
  6. Odtok sifonu
  7. Sifon
  8. Protizápachová uzávěra
  9. Matice
  10. Nastavitelné nohy

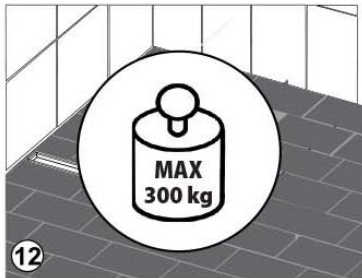
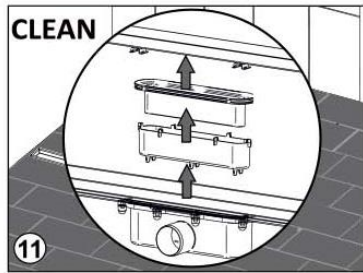
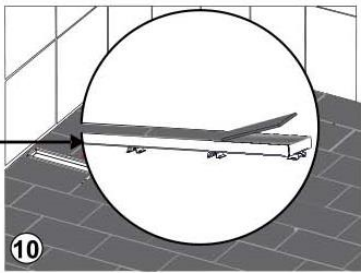
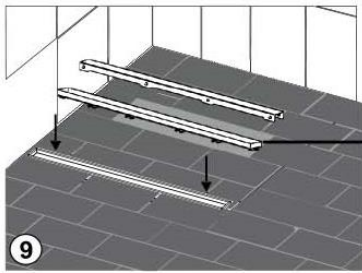
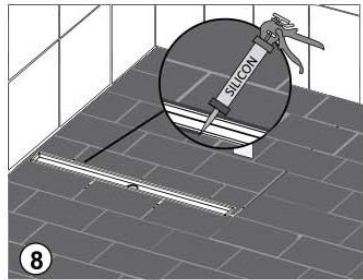
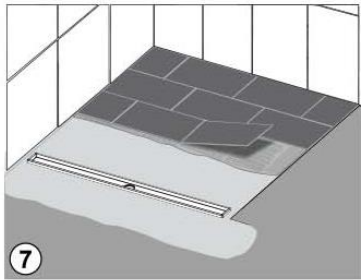
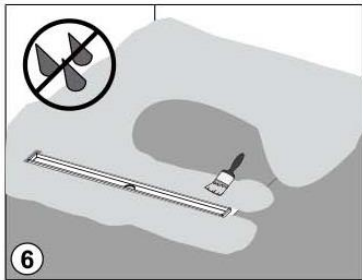
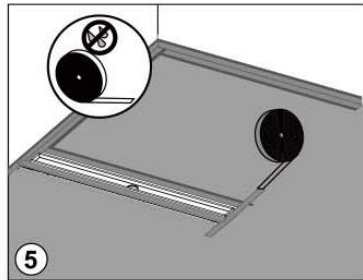
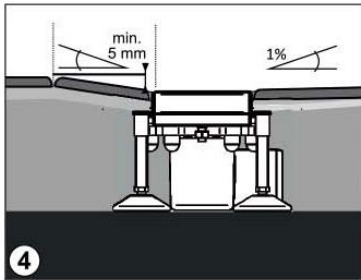
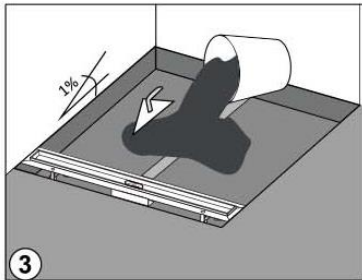
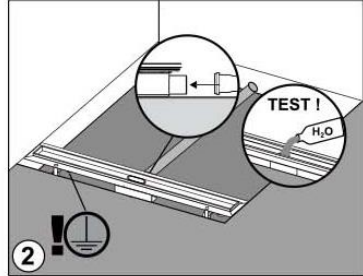
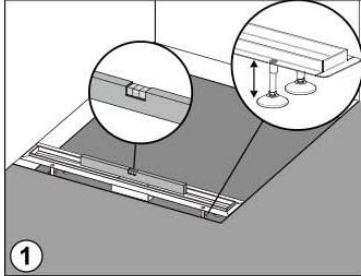

**DOVOZCE**

**SANJET s.r.o.** , nám. MUDr. J. Svobody 60 , 285 22 Zruč nad Sázavou  
tel.: 327 532 298 fax: 327 532 938 mobil: 603 177 127  
<http://www.sanjet.cz> , e-mail: [sanjet@sanjet.cz](mailto:sanjet@sanjet.cz)