

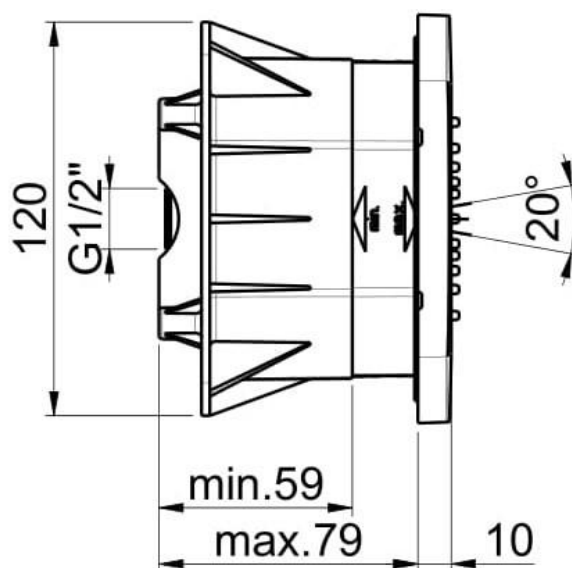

## TECHNICKÝ VÝKRES

KÓD VÝROBKU: **E044091**

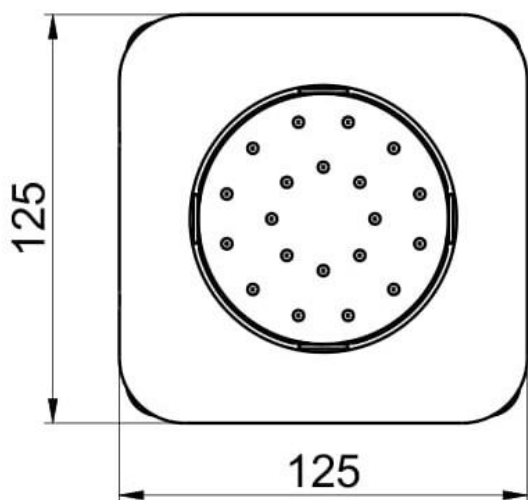

### MATERIÁL

CHROMOVANÁ MOSAZ

Nám. MUDr. J. Svobody 60, 28522 Zruč nad Sázavou – mob.: 603 177 127, tel.: 327 532 298

[sanjet@sanjet.cz](mailto:sanjet@sanjet.cz)

[www.sanjet.cz](http://www.sanjet.cz)